



Sports Floodlight

LXSP300W



Features:

- High lumen
- Easy combination
- Adjustable module
- IP66 & IK10
- 5YR Warranty

Areas of application:

Large stadiums, Sports fields, Tennis court, Golf course, Airports, Parking lots, Terminals, Power stations, Commercial parks etc.

	Energy saving up to 80%
---	--------------------------------------

	Long service life 50000 hrs
---	---------------------------------------

	Maintenance long life Free
---	---

CE CB RoHS



1 Parameter



Wattage	CRI	Power Factor
300W	Ra>70/80	>0.95
Operating Temp	IP & IK Grade	Luminous Flux
-40°C ~55°C	IP66 & IK10	51,000LM ±5%
Beam Angle	Rated Voltage	
30°/60°/90° Asymmetric G4	AC 100-240V 277V~, 50/60Hz	
Wind Test Data	Static load	
EPA = 0.74 ft ² FPA = 0.62 ft ² DC = 1.20	0.069 m ² x 2.4 kN = 165.6 N	

2 Beam angle

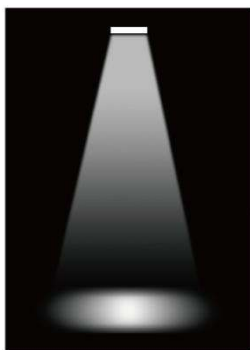

30°

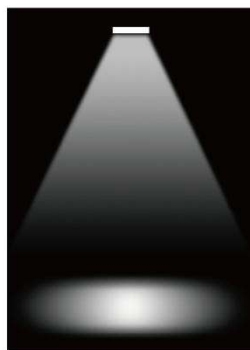

60°

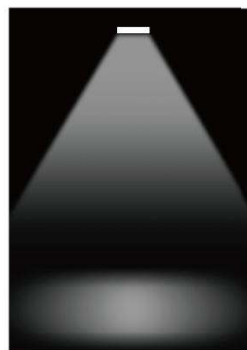

90°



Asymmetric G4

3 Installation

① Ground Installation

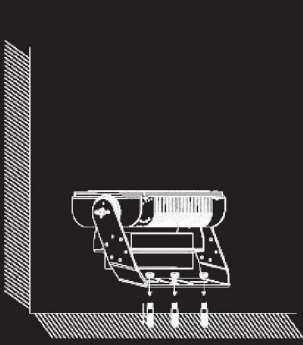

② Wall Installation

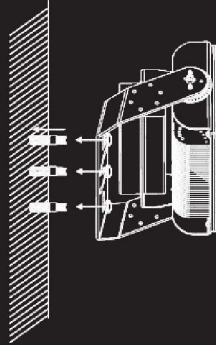

③ Pole Installation

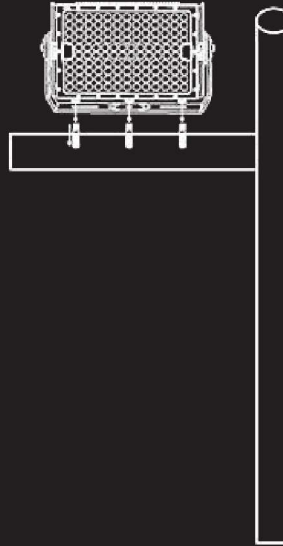

④ Ceiling Installation

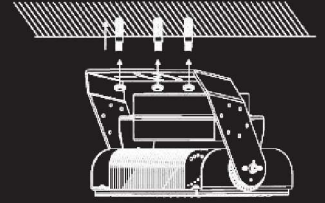

4 Dimensions

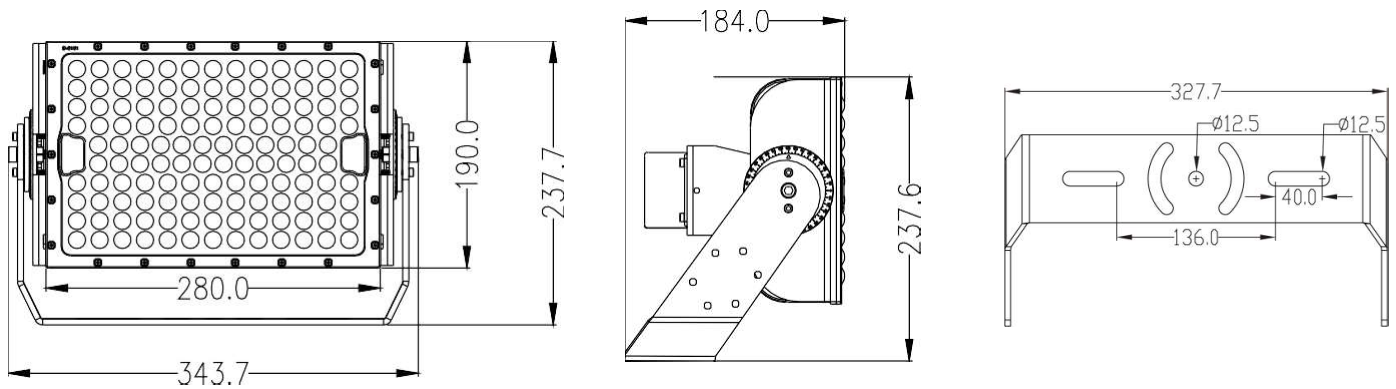

5 Packaging

Net Weight	Size of Box	Weight of Box	Box PCS / Carton		
6.0KG \pm 5%	39*29.5*23.5cm	6.6KG \pm 5%	1		